



HIGH EFFICIENCY CLASS-G ADSL LINE DRIVER

FEATURES

- **Low Total Power Consumption Increases ADSL Line Card Density (20 dBm on Line)**
 - 600 mW w/Active Termination (Full Bias)
 - 530 mW w/Active Termination (Low Bias)
- **Low MTPR of -74 dBc (All Bias Conditions)**
- **High Output Current of 500 mA (typ)**
- **Wide Supply Voltage Range of ±5 V to ±15 V [V_{CC(H)}] and ±3.3 V to ±15 V [V_{CC(L)}]**
- **Wide Output Voltage Swing of 43 V_{pp} Into 100-Ω Differential Load [V_{CC(H)} = ±12 V]**
- **Multiple Bias Modes Allow Low Quiescent Power Consumption for Short Line Lengths**
 - 160-mW/ch Full Bias Mode
 - 135-mW/ch Mid Bias Mode
 - 110-mW/ch Low Bias Mode
 - 75-mW/ch Terminate Only Mode
 - 13-mW/ch Shutdown Mode
- **Low Noise for Increased Receiver Sensitivity**
 - 3.3 pA/√Hz Noninverting Current Noise
 - 9.5 pA/√Hz Inverting Current Noise
 - 3.5 nV/√Hz Voltage Noise

APPLICATIONS

- **Ideal for Active Termination Full Rate ADSL DMT applications (20-dBm Line Power)**

DESCRIPTION

The THS6132 is a Class-G current feedback differential line driver ideal for full rate ADSL DMT systems. Its extremely low power consumption of 600 mW or lower is ideal for ADSL systems that must achieve high densities in ADSL central office rack applications. The unique patent pending architecture of the THS6132 allows the quiescent current to be much lower than existing line drivers while still achieving very high linearity. In addition, the multiple bias settings of the amplifiers allow for even lower power consumption for line lengths where the full performance of the amplifier is not required. The output voltage swing has been vastly improved over first generation Class-G amplifiers and allows the use of lower power supply voltages that help conserve power. For maximum flexibility, the THS6132 can be configured in classical Class-AB mode requiring only as few as one power supply.

Typical ADSL CO Line Driver Circuit Utilizing Active Impedance Supporting A 6.3 Crest Factor

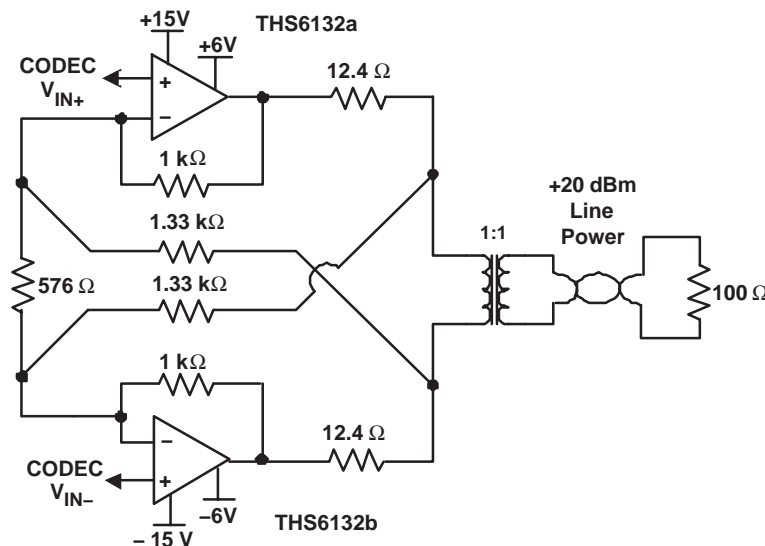

Please be aware that an important notice concerning availability, standard warranty, and use in critical applications of Texas Instruments semiconductor products and disclaimers thereto appears at the end of this data sheet.



These devices have limited built-in ESD protection. The leads should be shorted together or the device placed in conductive foam during storage or handling to prevent electrostatic damage.

ORDERING INFORMATION

PRODUCT	PACKAGE	PACKAGE CODE	SYMBOL	T _A	ORDER NUMBER	TRANSPORT MEDIA
THS6132VFP	TQFP-32 PowerPAD™	VFP-32	THS6132	-40°C to 85°C	THS6132VFP	Tube
					THS6132VFP	Tape and reel
THS6132RGW	Leadless 25-pin 5,mm x 5, mm PowerPAD™	RGW-25	6132		THS6132RGWR	Tape and reel

PACKAGE DISSIPATION RATINGS

PACKAGE	Θ _{JA}	Θ _{JC}	T _A ≤ 25°C POWER RATING(1)	T _A = 70°C POWER RATING(1)	T _A = 85°C POWER RATING(1)
VFP-32	29.4°C/W	0.96°C/W	3.57 W	2.04 W	1.53 W
RGW-25	31°C/W	1.7°C/W	3.39 W	1.94 W	1.45 W

(1) Power rating is determined with a junction temperature of 130°C. This is the point where distortion starts to substantially increase. Thermal management of the final PCB should strive to keep the junction temperature at or below 125°C for best performance.

ABSOLUTE MAXIMUM RATINGS

over operating free-air temperature range unless otherwise noted(1)

		THS6132
Supply voltage, V _{CC(H)} and V _{CC(L)} (2)		±16.5 V
Input voltage, V _I		±V _{CC(L)}
Output current, I _O (3)		900 mA
Differential input voltage, V _{IO}		±2 V
Maximum junction temperature, T _J (see Dissipation Rating Table for more information)		150°C
Operating free-air temperature, T _A		-40°C to 85°C
Storage temperature, T _{Stg}		65°C to 150°C
Lead temperature, 1,6 mm (1/16-inch) from case for 10 seconds		300°C
ESD ratings	HBM	1 kV
	CDM	500 V
	MM	200 V

(1) Stresses beyond those listed under “absolute maximum ratings” may cause permanent damage to the device. These are stress ratings only, and functional operation of the device at these or any other conditions beyond those indicated under “recommended operating conditions” is not implied. Exposure to absolute-maximum-rated conditions for extended periods may affect device reliability.

(2) V_{CC(H)} must always be greater than or equal to V_{CC(L)} for proper operation. Class-AB mode operation occurs when V_{CC(H)} is equal to V_{CC(L)} and is considered acceptable operation for the THS6132 even though it is not fully specified in this mode of operation.

(3) The THS6132 incorporates a PowerPAD on the underside of the chip. This acts as a heatsink and must be connected to a thermally dissipating plane for proper power dissipation. Failure to do so may result in exceeding the maximum junction temperature that could permanently damage the device. See TI Technical Brief SLMA002 for more information about utilizing the PowerPAD thermally enhanced package.

RECOMMENDED OPERATING CONDITIONS

		MIN	NOM	MAX	UNIT
Supply voltage	+V _{CC(H)} to -V _{CC(H)}	±V _{CC(L)}	±15	±16	V
	+V _{CC(L)} to -V _{CC(L)}	±3.3	±5	±V _{CC(H)}	
Operating free-air temperature, T _A		-40		85	°C

ELECTRICAL CHARACTERISTICS

over recommended operating free-air temperature range, T_A = 25°C, V_{CC(H)} = ±15 V, V_{CC(L)} = ±5 V R_F = 1.5 kΩ, Gain = +10, Full Bias Mode, R_L = 50 Ω (unless otherwise noted)

NOISE/DISTORTION PERFORMANCE							
PARAMETER		TEST CONDITIONS		MIN	TYP	MAX	UNIT
Multitone power ratio		Gain = +11, 163kHz to 1.1MHz DMT, +20 dBm Line Power, 1:1.1 transformer, active termination, synthesis factor = 4			-74		dBc
Receive band spill-over		Gain = +11, 25 kHz to 138 kHz with MTPR signal applied			-95		dBc
HD	Harmonic distortion (Differential Configuration, f = 1 MHz, V _{O(PP)} = 2 V, Gain = +10)	2 nd harmonic	Differential load = 100 Ω		-84		dBc
			Differential load = 25 Ω		-69		
		3 rd harmonic	Differential load = 100 Ω		-92		dBc
			Differential load = 25 Ω		-73		
V _n	Input voltage noise	f = 10 kHz			3.5		nV/√Hz
I _n	Input current noise	+Input	f = 10 kHz			3.3	pA/√Hz
		-Input				9.5	
Crosstalk		f = 1 MHz, R _L = 100 Ω,	V _{O(PP)} = 2 V, Gain = +2		-52		dBc
OUTPUT CHARACTERISTICS							
V _O	Single-ended output voltage swing	V _{CC(H)} = ±12 V	R _L = 100 Ω	±10.4	±10.8	V	
			R _L = 30 Ω	±9.9	±10.4		
		V _{CC(H)} = ±15 V	R _L = 100 Ω	±13.3	±13.8	V	
			R _L = 50 Ω	±13	±13.6		
Output voltage transition from V _{CC(L)} to V _{CC(H)} (Point where I _{CC(L)} = I _{CC(H)})		R _L = 50 Ω	V _{CC(L)} = ±5 V	±3.1		V	
			V _{CC(L)} = ±6 V	±3.9			
I _O	Output current (1)	R _L = 10 Ω	V _{CC(H)} = ±12 V	±500		mA	
			V _{CC(H)} = ±15 V	±400	±500		
I _(SC)	Short-circuit current (1)	R _L = 1 Ω	V _{CC(H)} = ±15 V	±750		mA	
Output resistance		Open-loop		5		Ω	
Output resistance—terminate mode		f = 1 MHz,	Gain = +10	0.35		Ω	
Output resistance—shutdown mode		f = 1 MHz,	Open-loop	5.5		kΩ	

(1) A heatsink is required to keep the junction temperature below absolute maximum rating when an output is heavily loaded or shorted. See Absolute Maximum Ratings section for more information.

ELECTRICAL CHARACTERISTICS (continued)

over recommended operating free-air temperature range, $T_A = 25^\circ\text{C}$, $V_{CC(H)} = \pm 15\text{ V}$, $V_{CC(L)} = \pm 5\text{ V}$ $R_F = 1.5\text{ k}\Omega$, Gain = +10, Full Bias Mode, $R_L = 50\ \Omega$ (unless otherwise noted)

POWER SUPPLY								
PARAMETER		TEST CONDITIONS		MIN	TYP	MAX	UNIT	
$V_{CC(x)}$	Operating range	$\pm V_{CC(H)}$		$\pm V_{CC(L)}$	± 15	± 16.5	V	
		$\pm V_{CC(L)}$		± 3	± 5	$\pm V_{CC(H)}$		
I_{CC}	Quiescent current (each driver) Full-bias mode (Bias-1 = 1, Bias-2 = 1, Bias-3 = X) (I_{CC} trimmed with $V_{CC(H)} = \pm 15\text{ V}$, $V_{CC(L)} = \pm 5\text{ V}$)	$V_{CC(L)} = \pm 5\text{ V};$ ($V_{CC(H)} = \pm 15\text{ V}$)	$T_A = 25^\circ\text{C}$	5.7	6.4	7.5	mA	
			$T_A = \text{full range}$			8.1		
		$V_{CC(L)} = \pm 6\text{ V};$ ($V_{CC(H)} = \pm 15\text{ V}$)	$T_A = 25^\circ\text{C}$		6.7			mA
			$T_A = \text{full range}$					
		$V_{CC(H)} = \pm 12\text{ V};$ ($V_{CC(L)} = \pm 5\text{ V}$)	$T_A = 25^\circ\text{C}$		3.1			mA
			$T_A = \text{full range}$					
		$V_{CC(H)} = \pm 15\text{ V};$ ($V_{CC(L)} = \pm 5\text{ V}$)	$T_A = 25^\circ\text{C}$	2.9	3.25	3.75		mA
			$T_A = \text{full range}$			4.25		
	Quiescent current (each driver) Variable bias modes, $V_{CC(L)} = \pm 5\text{ V}$	Mid; Bias-1 = 1, Bias-2 = 0, Bias-3 = 1			5.0	5.6	6.8	mA
		Low; Bias-1 = 1, Bias-2 = 0, Bias-3 = 0			4.25	4.8	6.0	
		Terminate; Bias-1 = 0, Bias-2 = 1, Bias-3 = X ⁽¹⁾			3.2	3.8	4.5	
		Shutdown; Bias-1 = 0, Bias-2 = 0, Bias-3 = X ⁽¹⁾				1	1.3	
	Quiescent current (each driver) Variable bias modes, $V_{CC(H)} = \pm 15\text{ V}$	Mid; Bias-1 = 1, Bias-2 = 0, Bias-3 = 1			2.4	2.7	3.0	mA
		Low ; Bias-1 = 1, Bias-2 = 0, Bias-3 = 0			1.9	2.15	2.4	
		Terminate; Bias-1 = 0, Bias-2 = 1, Bias-3 = X ⁽¹⁾			1.1	1.3	1.5	
		Shutdown ; Bias-1 = 0, Bias-2 = 0, Bias-3 = X ⁽¹⁾				0.1	0.5	
PSRR	Power supply rejection ratio ($\Delta V_{CC(x)} = \pm 1\text{ V}$)	$V_{CC(L)} = \pm 5\text{ V}$	$T_A = 25^\circ\text{C}$	-70	-82		dB	
			$T_A = \text{full range}$		-68			
		$V_{CC(H)} = \pm 15\text{ V}$	$T_A = 25^\circ\text{C}$	-70	-82			
			$T_A = \text{full range}$		-68			

(1) X is used to denote a logic state of either 1 or 0.

ELECTRICAL CHARACTERISTICS (continued)

 over recommended operating free-air temperature range, $T_A = 25^\circ\text{C}$, $V_{CC(H)} = \pm 15\text{ V}$, $V_{CC(L)} = \pm 5\text{ V}$, $R_F = 1.5\text{ k}\Omega$, Gain = +10, Full Bias Mode, $R_L = 50\ \Omega$ (unless otherwise noted)

DYNAMIC PERFORMANCE							
PARAMETER		TEST CONDITIONS		MIN	TYP	MAX	UNIT
BW	Single-ended small-signal bandwidth (-3 dB), $V_O = 0.1\text{ V}_{\text{rms}}$	$R_L = 100\ \Omega$	Gain = +1, $R_F = 750\ \Omega$		80		MHz
			Gain = +2, $R_F = 620\ \Omega$		70		
			Gain = +5, $R_F = 500\ \Omega$		60		
			Gain = +10, $R_F = 1\text{ k}\Omega$		20		
		$R_L = 25\ \Omega$	Gain = +1, $R_F = 750\ \Omega$		60		MHz
			Gain = +2, $R_F = 620\ \Omega$		55		
			Gain = +5, $R_F = 500\ \Omega$		50		
			Gain = +10, $R_F = 1\text{ k}\Omega$		17		
SR	Single-ended slew-rate ⁽¹⁾	$V_O = 20\text{ V}_{\text{pp}}$, Gain = +10			300		V/ μs

(1) Slew-rate is defined from the 25% to the 75% output levels

DC PERFORMANCE							
PARAMETER		TEST CONDITIONS		MIN	TYP	MAX	UNIT
V_{OS}	Input offset voltage	$V_{CC(L)} = \pm 5\text{ V}, \pm 6\text{ V}$	$T_A = 25^\circ\text{C}$		1	15	mV
			$T_A = \text{full range}$			20	
	Differential offset voltage		$T_A = 25^\circ\text{C}$		0.3	6	
			$T_A = \text{full range}$			8	
	Offset drift		$T_A = \text{full range}$		40		$\mu\text{V}/^\circ\text{C}$
I_{IB}	-Input bias current	$V_{CC(L)} = \pm 5\text{ V}, \pm 6\text{ V}$	$T_A = 25^\circ\text{C}$		1	15	μA
			$T_A = \text{full range}$			20	
	+ Input bias current		$T_A = 25^\circ\text{C}$		1.5	15	
			$T_A = \text{full range}$			20	
Z_{OL}	Open loop transimpedance	$R_L = 1\text{ k}\Omega$			2		M Ω

ELECTRICAL CHARACTERISTICS (continued)

over recommended operating free-air temperature range, $T_A = 25^\circ\text{C}$, $V_{CC(H)} = \pm 15\text{ V}$, $V_{CC(L)} = \pm 5\text{ V}$ $R_F = 1.5\text{ k}\Omega$, Gain = +10, Full Bias Mode, $R_L = 50\ \Omega$ (unless otherwise noted)

INPUT CHARACTERISTICS							
PARAMETER		TEST CONDITIONS		MIN	TYP	MAX	UNIT
V_{ICR}	Input common-mode voltage range(1)	$V_{CC(L)} = \pm 5\text{ V}$	$T_A = 25^\circ\text{C}$	± 2.7	± 3.0	V	
			$T_A = \text{full range}$	± 2.6			
		$V_{CC(L)} = \pm 6\text{ V}$	$T_A = 25^\circ\text{C}$		± 4.0		
REF pin input voltage range	$V_{CC-(L)} = \pm 5\text{ V}$			± 2.5	V		
	$V_{CC(L)} = \pm 6\text{ V}$			± 3.5			
CMRR	Common-mode rejection ratio	$V_{CC(L)} = \pm 5\text{ V}, \pm 6\text{ V}$	$T_A = 25^\circ\text{C}$	60	67	dB	
			$T_A = \text{full range}$	57			
R_I	Input resistance	+ Input			800	$\text{k}\Omega$	
		- Input			45	Ω	
C_I	Differential Input capacitance				1.2	pF	

(1) To conserve as much power as possible, the input stage of the THS6132 is powered from the $V_{CC(L)}$ supplies and is limited by the $V_{CC(L)}$ supply voltage. For Class-AB operation, connect the $V_{CC(L)}$ supplies to $V_{CC(H)}$.

LOGIC CONTROL CHARACTERISTICS							
PARAMETER		TEST CONDITIONS		MIN	TYP	MAX	UNIT
V_{IH}	Bias pin voltage for logic 1	Relative to DGND pin voltage		2.0			V
V_{IL}	Bias pin voltage for logic 0	Relative to DGND pin voltage				0.8	V
I_{IH}	Bias pin current for logic 1	$V_{IH} = 5\text{ V}, \text{ DGND} = 0\text{ V}$		-0.1		-0.2	μA
I_{IL}	Bias pin current for logic 0	$V_{IL} = 0\text{ V}, \text{ DGND} = 0\text{ V}$		-0.1		-0.2	μA
	Transition time—logic 0 to logic 1(1)				0.1		μs
	Transition time—logic 1 to logic 0(1)				0.2		μs
	DGND useable range			$-V_{CC(H)}$		$+V_{CC(H)} - 5$	V

(1) Transition time is defined as the time from when the logic signal is applied to the time when the supply current has reached half its final value.

LOGIC TABLE					
BIAS-1	BIAS-2	BIAS-3	FUNCTION	DESCRIPTION	
1	1	X(1)	Full bias mode	Amplifiers ON with lowest distortion possible	
1	0	1	Mid bias mode	Amplifiers ON with power savings with a reduction in distortion performance	
1	0	0	Low bias mode	Amplifiers ON with enhanced power savings and a reduction of distortion performance	
0	1	X(1)	Terminate mode	Lowest power state with +Vin pins internally connect to REF pin and output has low impedance	
0	0	X(1)	Shutdown mode	Amplifiers OFF and output has high impedance	

(1) X is used to denote a logic state of either 1 or 0.

NOTE: The default state for all logic pins is a logic one (1).

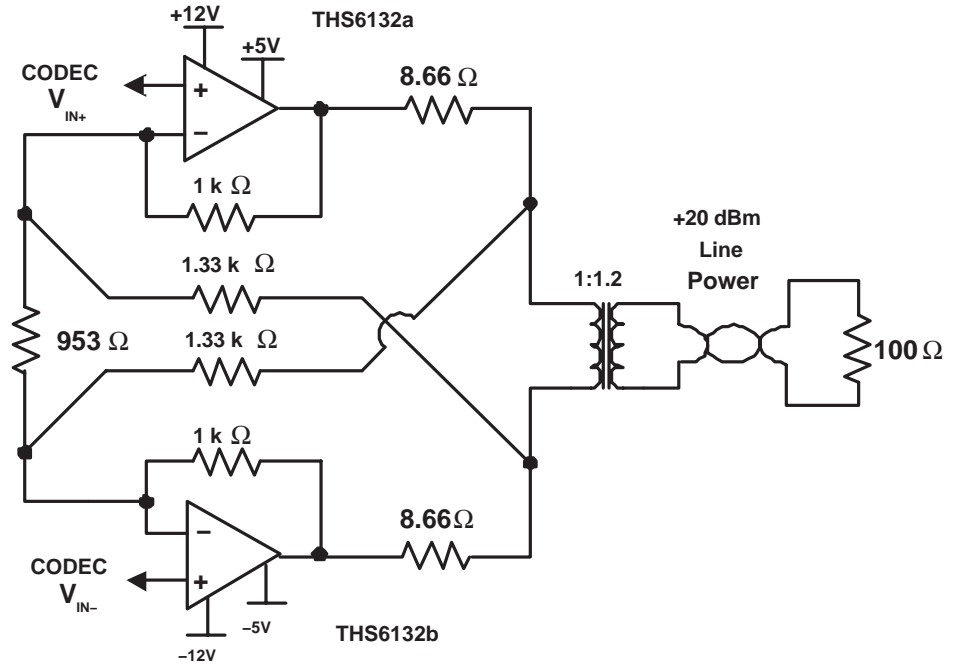
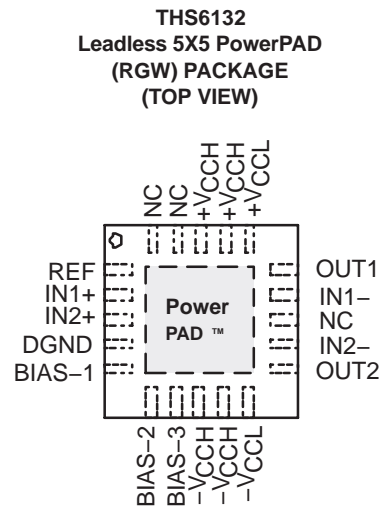
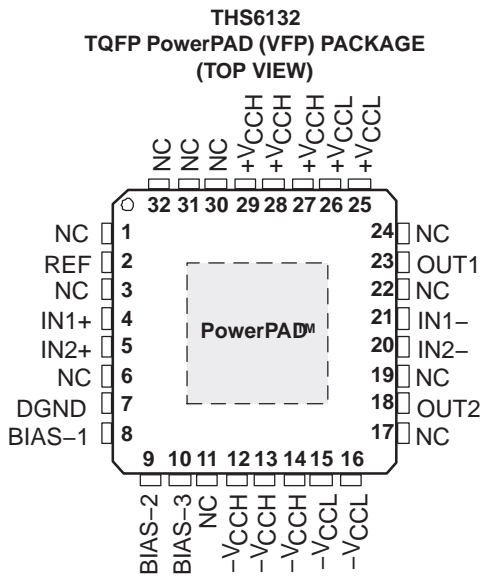

Figure 1. ± 12 V Active Termination ADSL CO Line Driver Circuit (Synthesis Factor = 4; CF = 5.6)

PIN ASSIGNMENTS



TYPICAL CHARACTERISTICS

Table of Graphs

		FIGURE
Output voltage headroom	vs Output current	2
Common-mode rejection ratio	vs Frequency	3
Crosstalk	vs Frequency	4
Quiescent current	vs Temperature	5, 6
Large signal bandwidth	vs Frequency	7 – 10
Noise	vs Frequency	11
Overdrive recovery		12
Power supply rejection ratio	vs Frequency	13
Small signal frequency response		14, 15, 16
Small signal bandwidth	vs Frequency	17 – 28
Slew rate	vs Output voltage	29
Closed-loop output impedance	vs Frequency	30, 31
Shutdown response		32
Common-mode rejection ratio	vs Common-mode input voltage	33
Input bias current	vs Temperature	34
Input offset voltage	vs Temperature	35
Current draw distribution	vs Output voltage	36, 37
Output voltage	vs Temperature	38
Differential distortion	vs Frequency	39 – 52
Differential distortion	vs Differential output voltage	53 – 63
Single ended distortion	vs Frequency	64, 65

OUTPUT VOLTAGE HEADROOM
vs
OUTPUT CURRENT

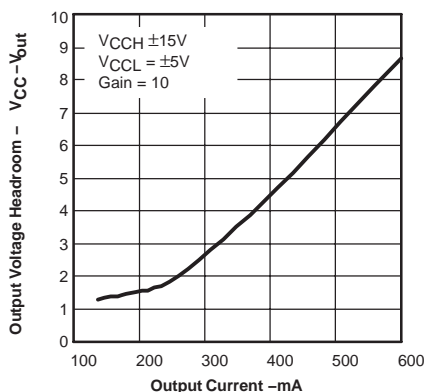

Figure 2

COMMON-MODE REJECTION RATIO
vs
FREQUENCY

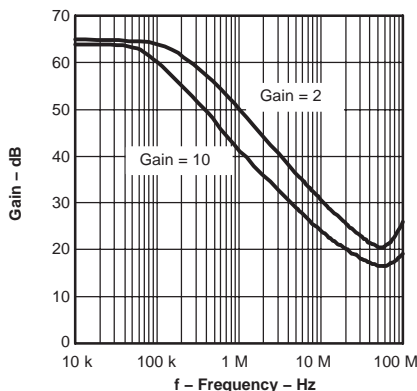

Figure 3

CROSSTALK
vs
FREQUENCY

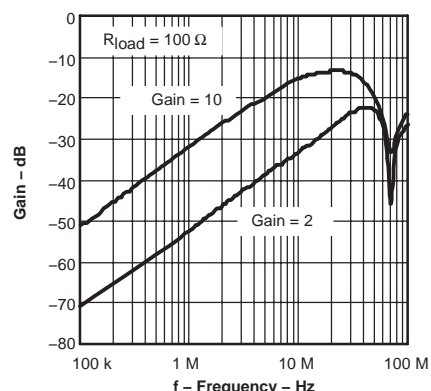

Figure 4

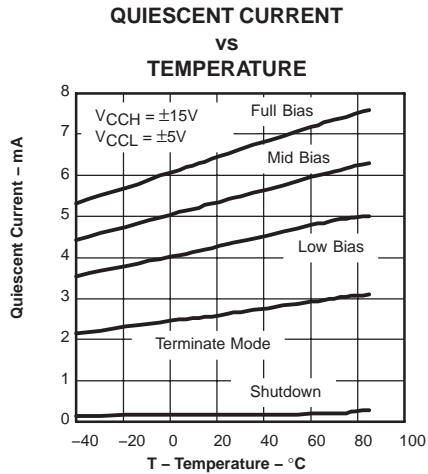

Figure 5

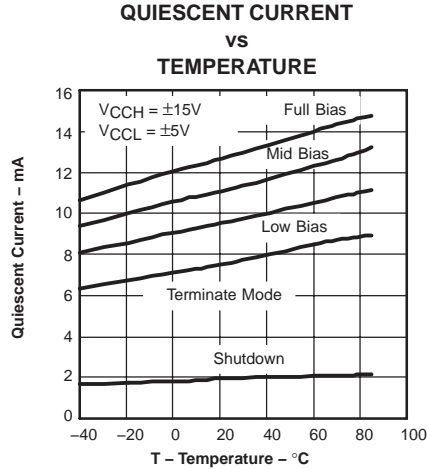

Figure 6

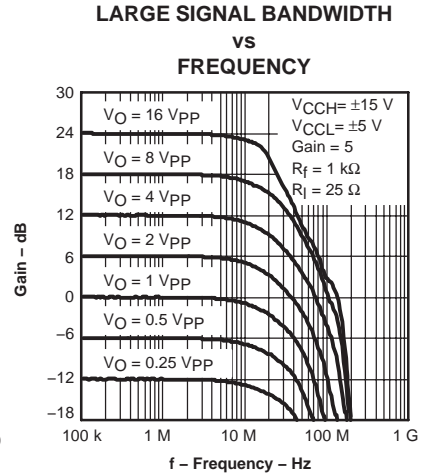

Figure 7

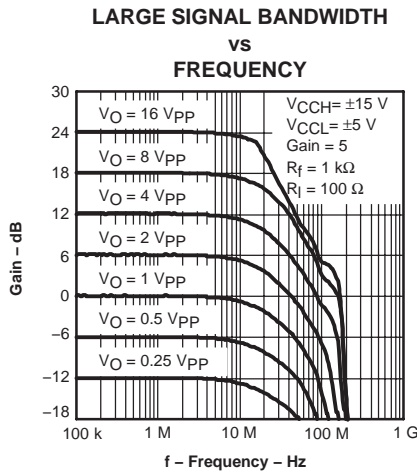

Figure 8

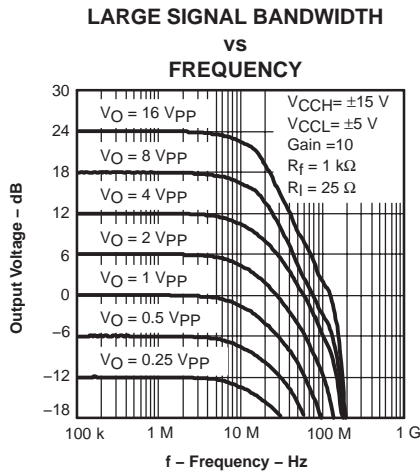

Figure 9

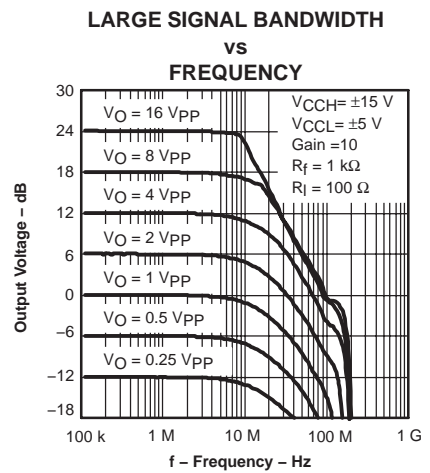

Figure 10

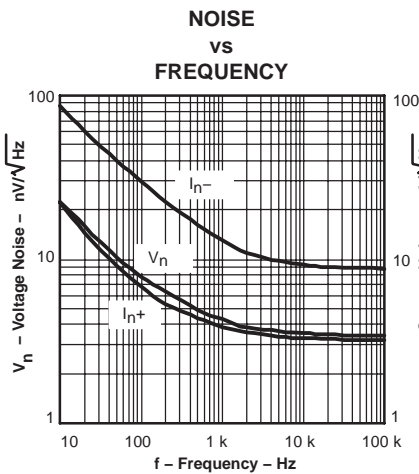

Figure 11

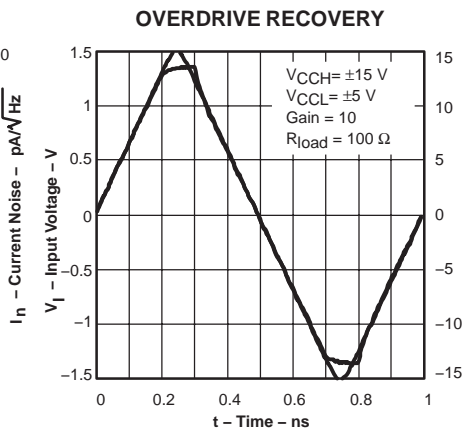

Figure 12

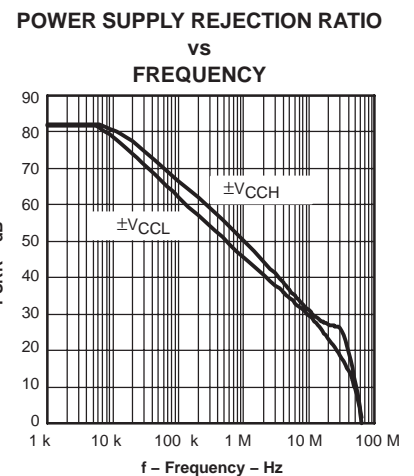

Figure 13

SMALL SIGNAL FREQUENCY RESPONSE

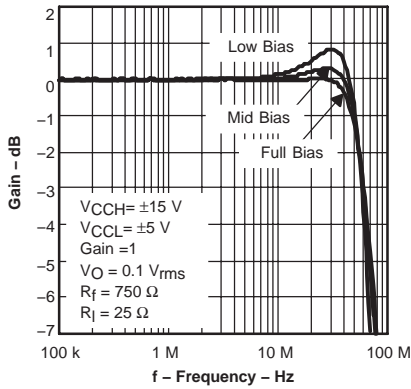

Figure 14

SMALL SIGNAL FREQUENCY RESPONSE

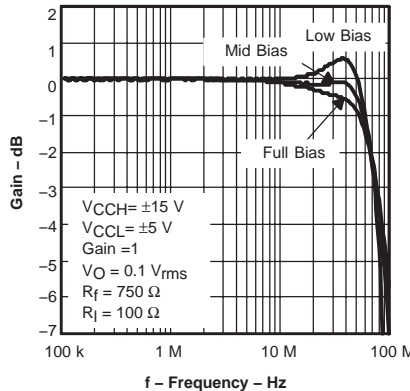

Figure 15

SMALL SIGNAL FREQUENCY RESPONSE

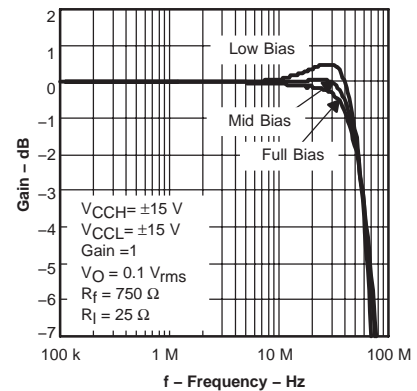

Figure 16

SMALL SIGNAL BANDWIDTH
vs
FREQUENCY

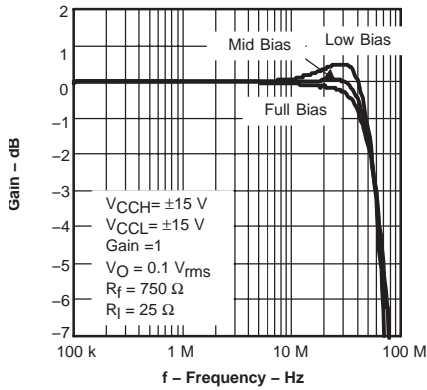

Figure 17

SMALL SIGNAL BANDWIDTH
vs
FREQUENCY

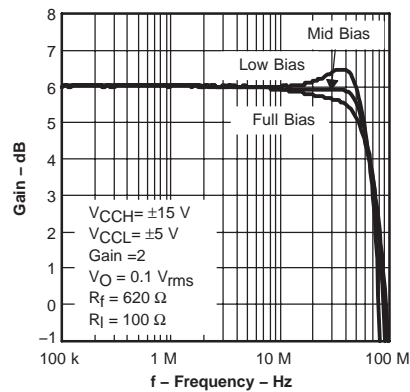

Figure 18

SMALL SIGNAL BANDWIDTH
vs
FREQUENCY

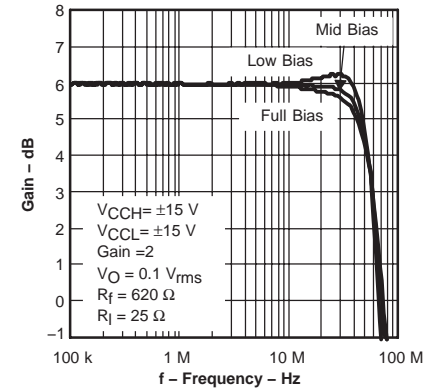

Figure 19

SMALL SIGNAL BANDWIDTH
vs
FREQUENCY

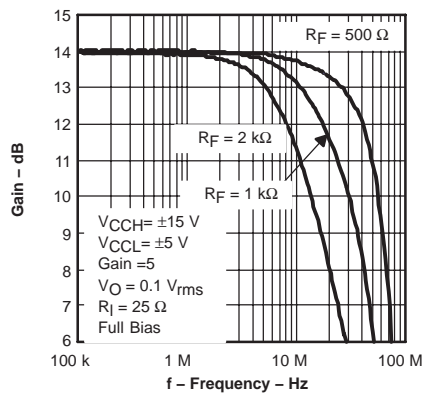

Figure 20

SMALL SIGNAL BANDWIDTH
vs
FREQUENCY

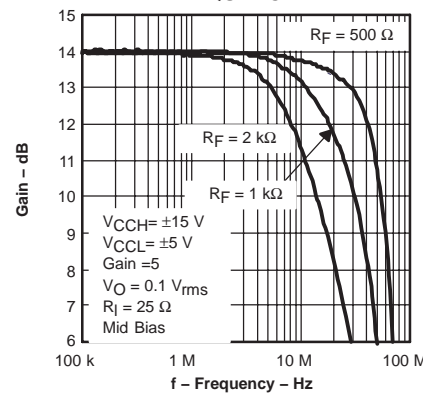

Figure 21

SMALL SIGNAL BANDWIDTH
vs
FREQUENCY

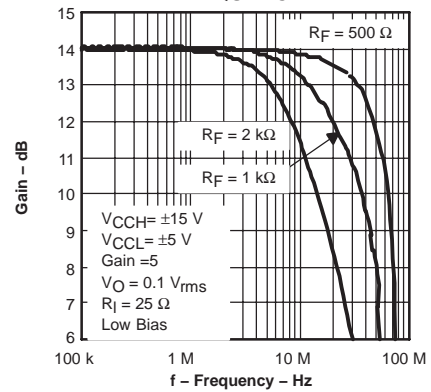

Figure 22

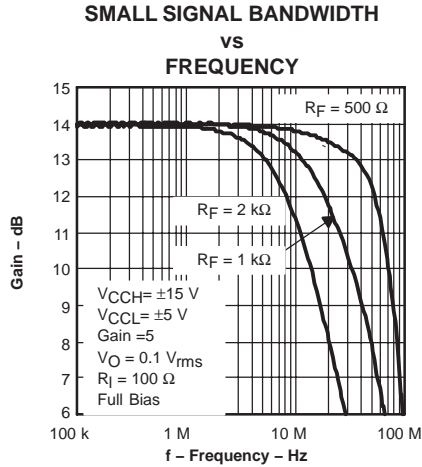

Figure 23

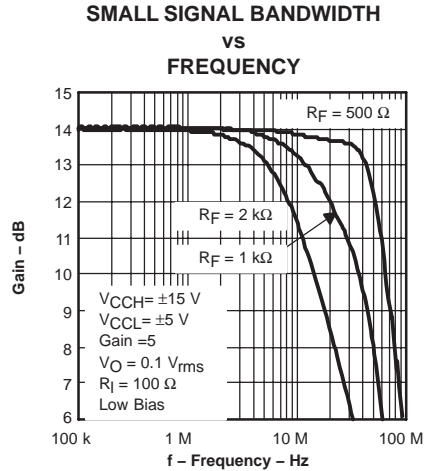

Figure 24

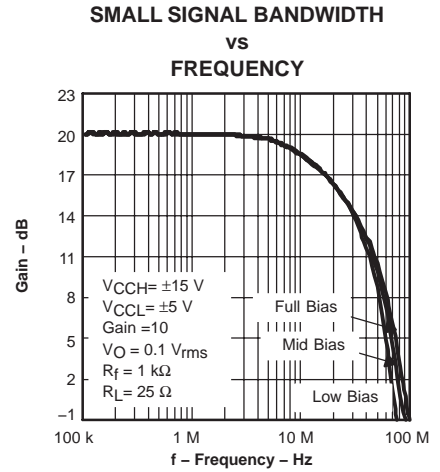

Figure 25

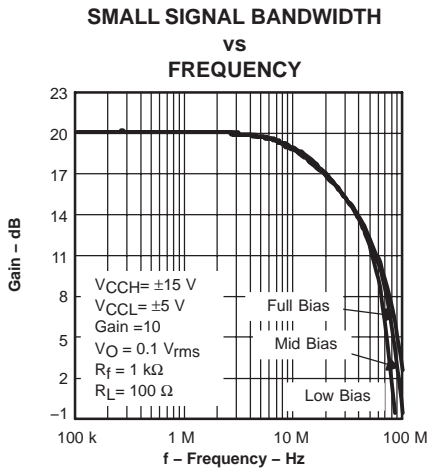

Figure 26

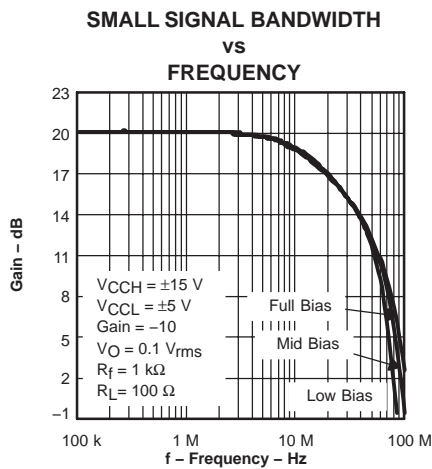

Figure 27

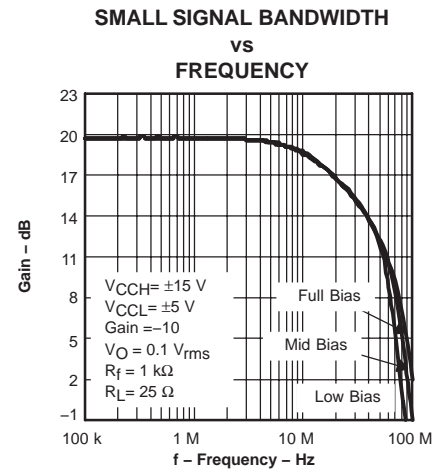

Figure 28

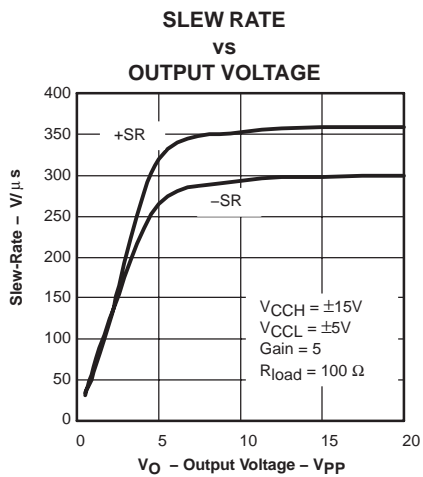

Figure 29

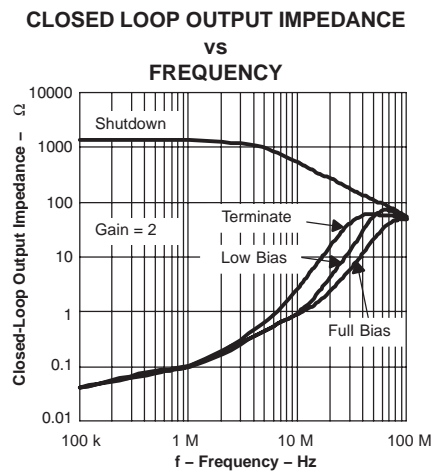

Figure 30

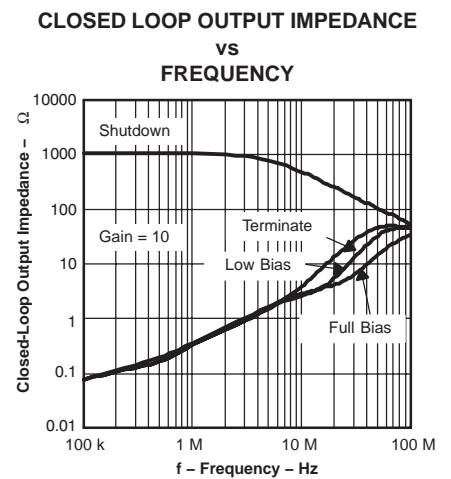

Figure 31

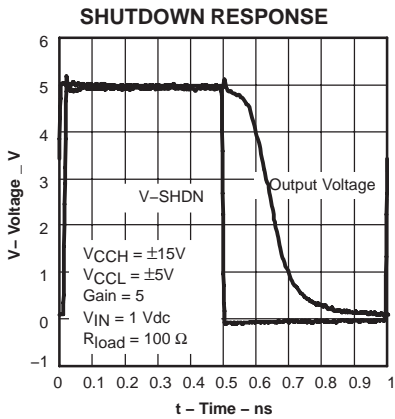

Figure 32

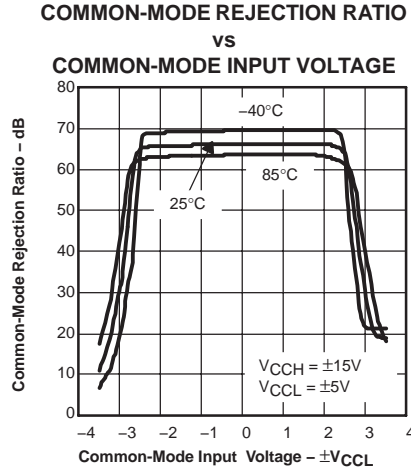

Figure 33

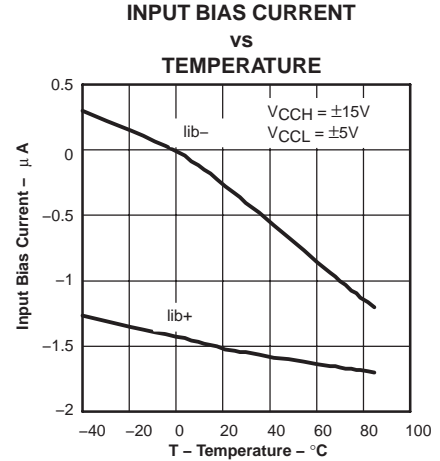

Figure 34

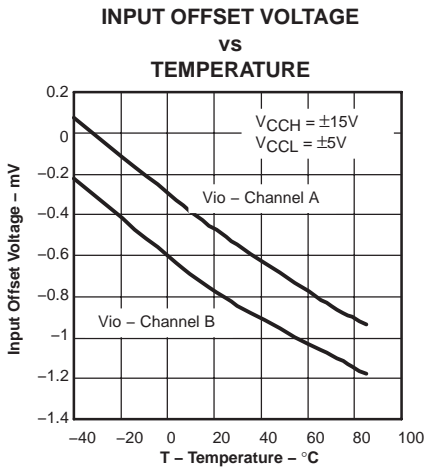

Figure 35

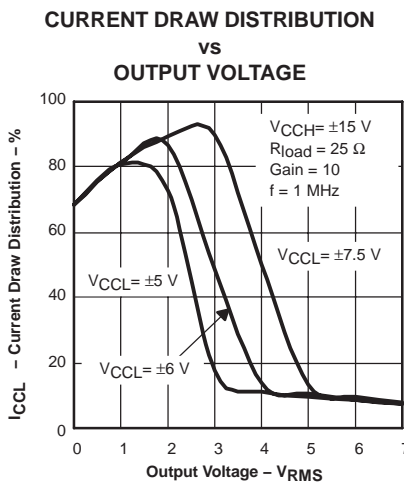

Figure 36

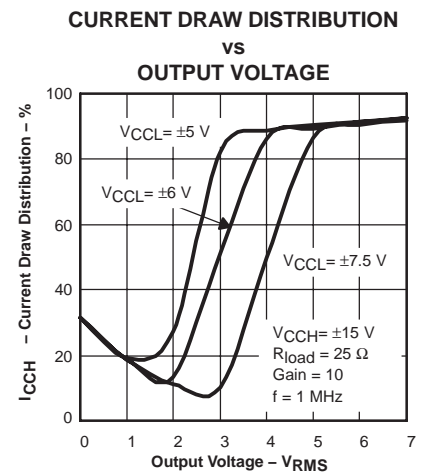

Figure 37

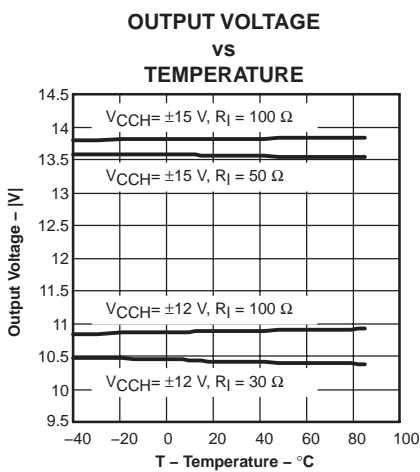

Figure 38

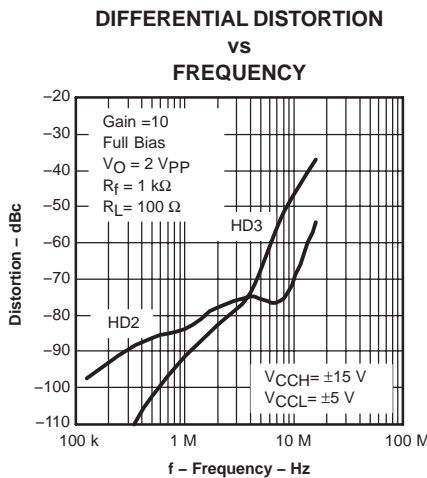

Figure 39

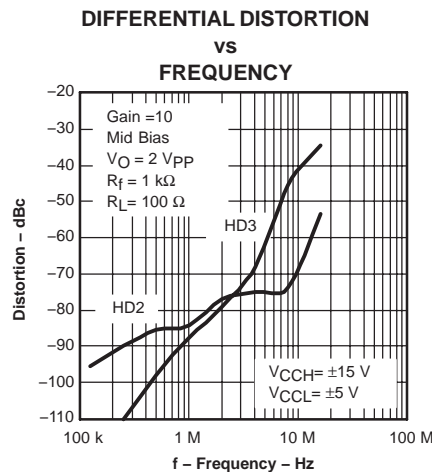

Figure 40

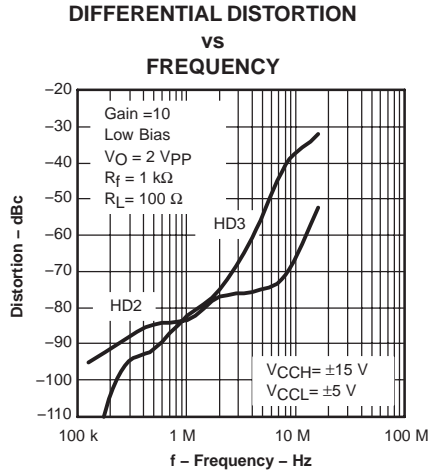

Figure 41

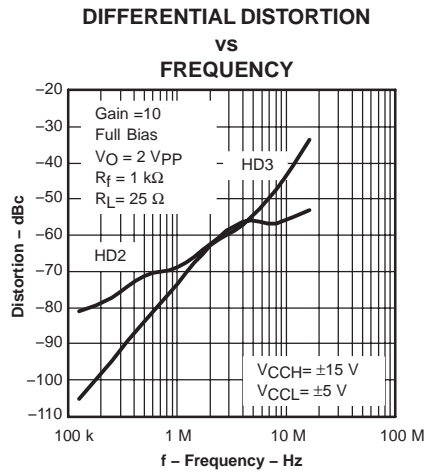

Figure 42

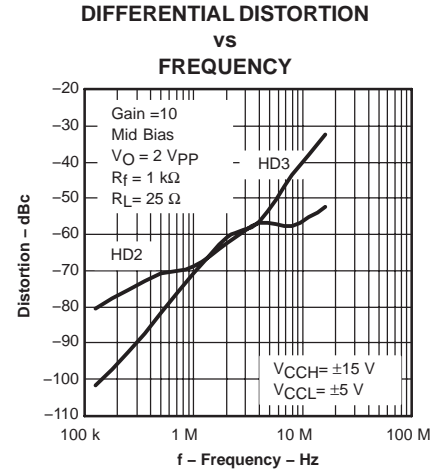

Figure 43

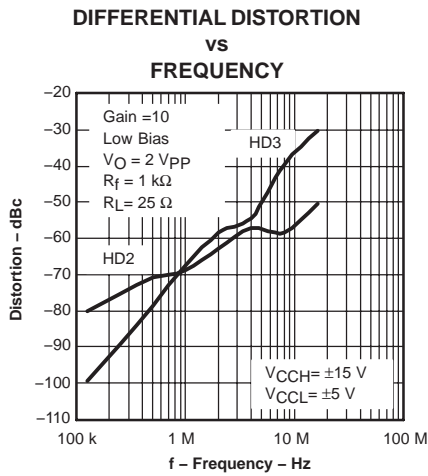

Figure 44

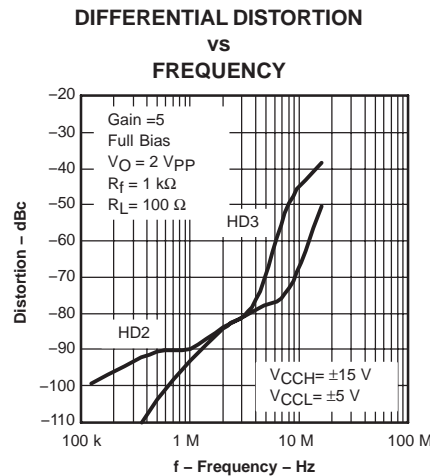

Figure 45

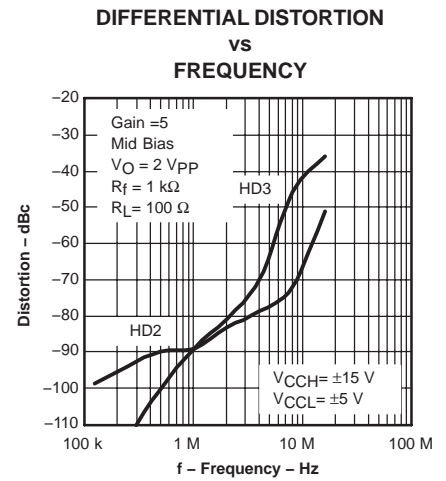

Figure 46

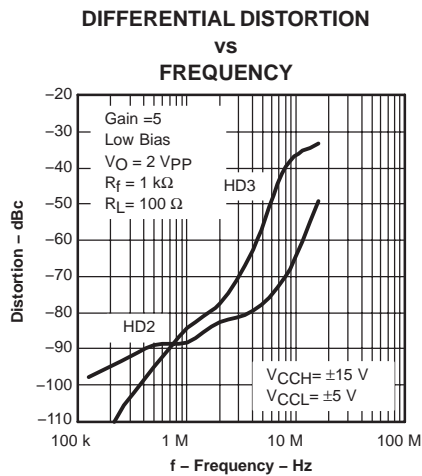

Figure 47

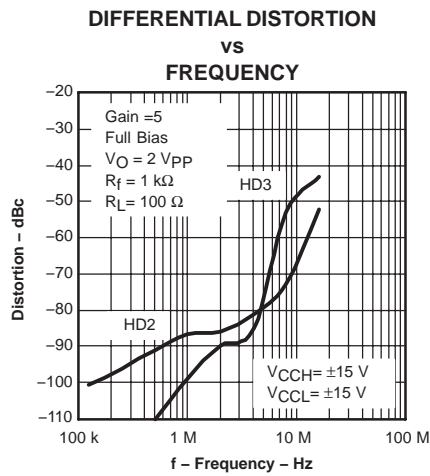

Figure 48

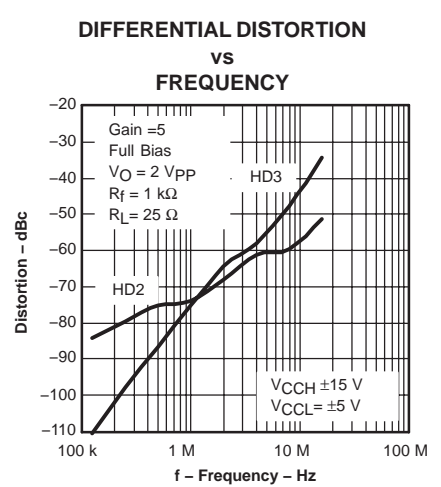

Figure 49

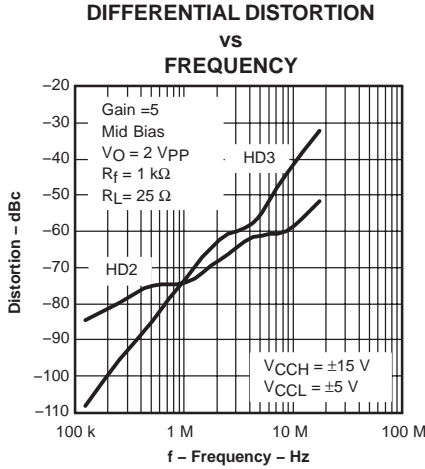

Figure 50

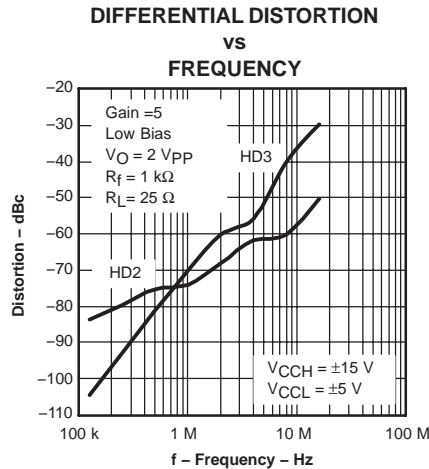

Figure 51

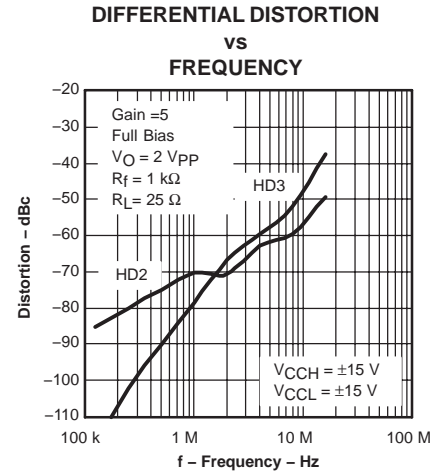

Figure 52

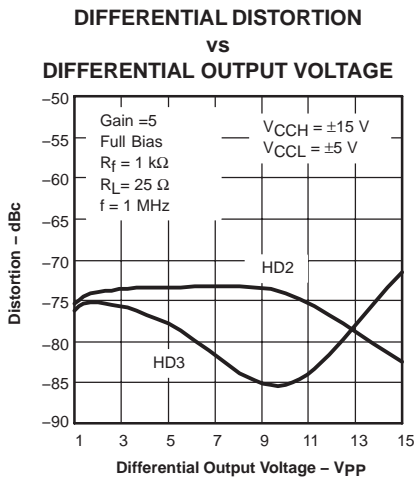

Figure 53

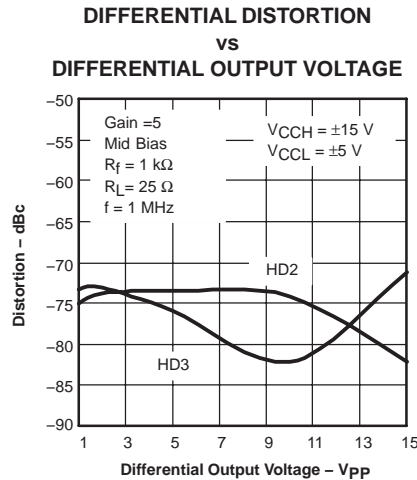

Figure 54

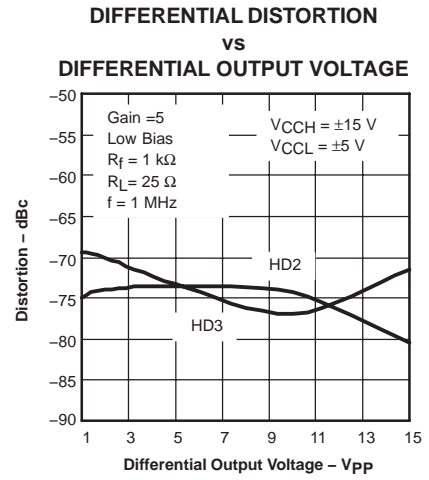

Figure 55

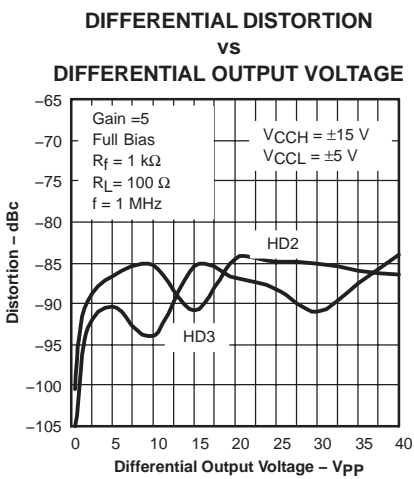

Figure 56

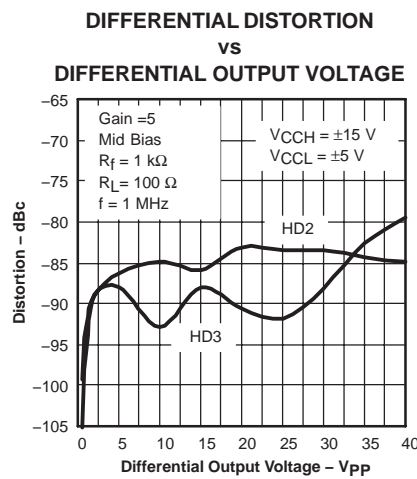

Figure 57

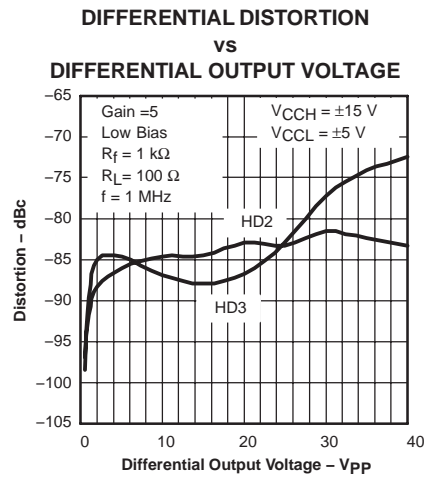

Figure 58

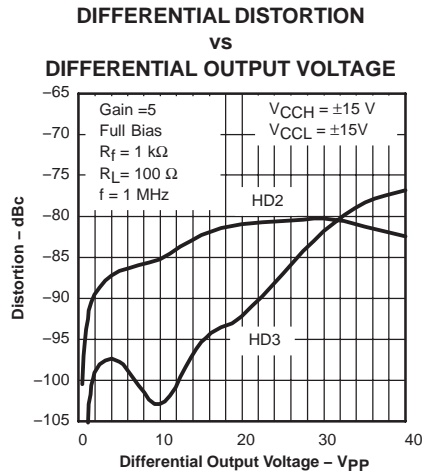

Figure 59

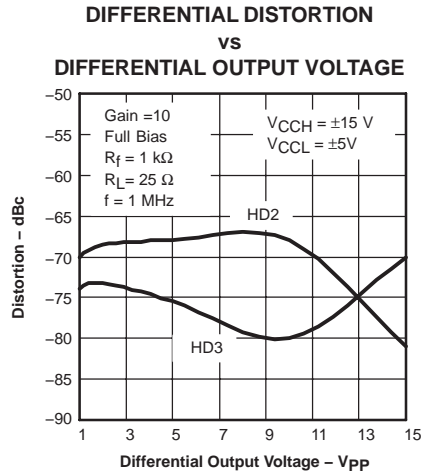

Figure 60

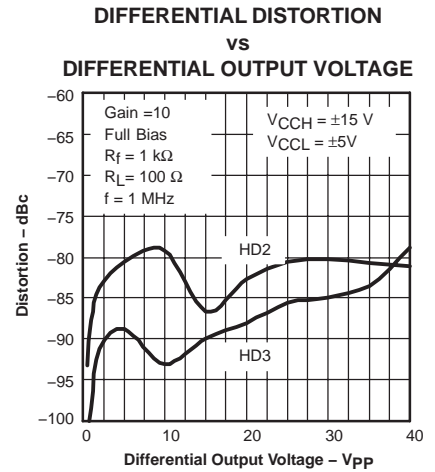

Figure 61

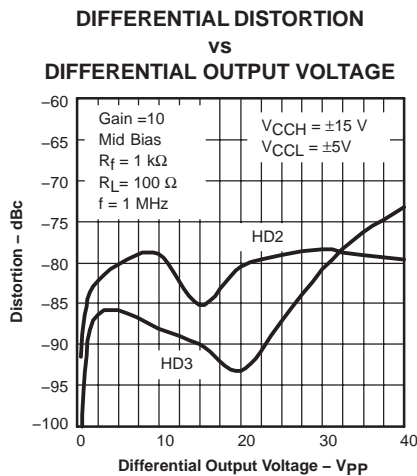

Figure 62

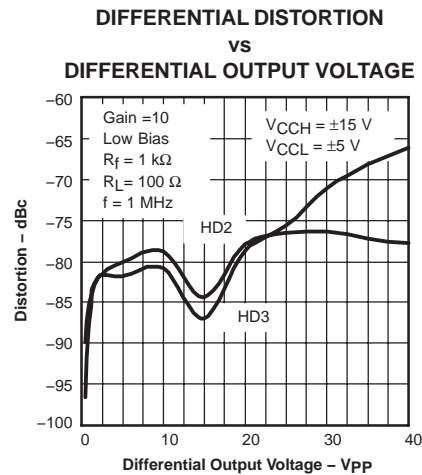

Figure 63

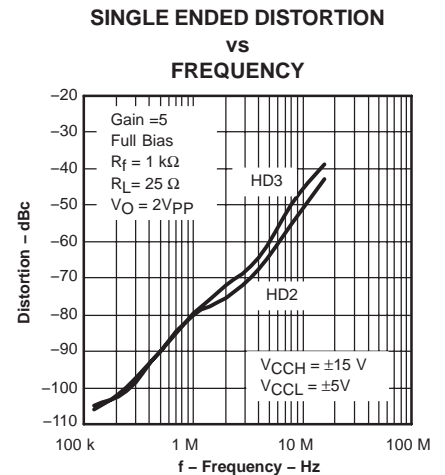

Figure 64

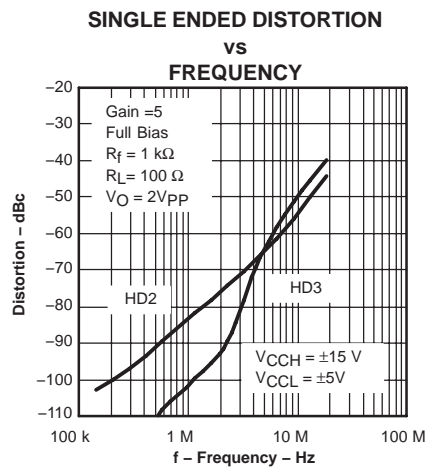

Figure 65

PACKAGING INFORMATION

Orderable Device	Status ⁽¹⁾	Package Type	Package Drawing	Pins	Package Qty	Eco Plan ⁽²⁾	Lead/Ball Finish	MSL Peak Temp ⁽³⁾
THS6132RGWR	ACTIVE	QFN	RGW	20	3000	Green (RoHS & no Sb/Br)	CU NIPDAU	Level-2-260C-1 YEAR
THS6132RGWRG4	ACTIVE	QFN	RGW	20	3000	Green (RoHS & no Sb/Br)	CU NIPDAU	Level-2-260C-1 YEAR
THS6132VFP	ACTIVE	HLQFP	VFP	32	250	Green (RoHS & no Sb/Br)	CU NIPDAU	Level-2-260C-1 YEAR
THS6132VFPG4	ACTIVE	HLQFP	VFP	32		TBD	Call TI	Call TI
THS6132VFPR	ACTIVE	HLQFP	VFP	32	1000	Green (RoHS & no Sb/Br)	CU NIPDAU	Level-2-260C-1 YEAR
THS6132VFPRG4	ACTIVE	HLQFP	VFP	32	1000	Green (RoHS & no Sb/Br)	CU NIPDAU	Level-2-260C-1 YEAR

⁽¹⁾ The marketing status values are defined as follows:

ACTIVE: Product device recommended for new designs.

LIFEBUY: TI has announced that the device will be discontinued, and a lifetime-buy period is in effect.

NRND: Not recommended for new designs. Device is in production to support existing customers, but TI does not recommend using this part in a new design.

PREVIEW: Device has been announced but is not in production. Samples may or may not be available.

OBSOLETE: TI has discontinued the production of the device.

⁽²⁾ Eco Plan - The planned eco-friendly classification: Pb-Free (RoHS), Pb-Free (RoHS Exempt), or Green (RoHS & no Sb/Br) - please check <http://www.ti.com/productcontent> for the latest availability information and additional product content details.

TBD: The Pb-Free/Green conversion plan has not been defined.

Pb-Free (RoHS): TI's terms "Lead-Free" or "Pb-Free" mean semiconductor products that are compatible with the current RoHS requirements for all 6 substances, including the requirement that lead not exceed 0.1% by weight in homogeneous materials. Where designed to be soldered at high temperatures, TI Pb-Free products are suitable for use in specified lead-free processes.

Pb-Free (RoHS Exempt): This component has a RoHS exemption for either 1) lead-based flip-chip solder bumps used between the die and package, or 2) lead-based die adhesive used between the die and leadframe. The component is otherwise considered Pb-Free (RoHS compatible) as defined above.

Green (RoHS & no Sb/Br): TI defines "Green" to mean Pb-Free (RoHS compatible), and free of Bromine (Br) and Antimony (Sb) based flame retardants (Br or Sb do not exceed 0.1% by weight in homogeneous material)

⁽³⁾ MSL, Peak Temp. -- The Moisture Sensitivity Level rating according to the JEDEC industry standard classifications, and peak solder temperature.

Important Information and Disclaimer:The information provided on this page represents TI's knowledge and belief as of the date that it is provided. TI bases its knowledge and belief on information provided by third parties, and makes no representation or warranty as to the accuracy of such information. Efforts are underway to better integrate information from third parties. TI has taken and continues to take reasonable steps to provide representative and accurate information but may not have conducted destructive testing or chemical analysis on incoming materials and chemicals. TI and TI suppliers consider certain information to be proprietary, and thus CAS numbers and other limited information may not be available for release.

In no event shall TI's liability arising out of such information exceed the total purchase price of the TI part(s) at issue in this document sold by TI to Customer on an annual basis.

TAPE AND REEL INFORMATION



QUADRANT ASSIGNMENTS FOR PIN 1 ORIENTATION IN TAPE



*All dimensions are nominal

Device	Package Type	Package Drawing	Pins	SPQ	Reel Diameter (mm)	Reel Width W1 (mm)	A0 (mm)	B0 (mm)	K0 (mm)	P1 (mm)	W (mm)	Pin1 Quadrant
THS6132RGWR	QFN	RGW	20	3000	330.0	12.4	5.3	5.3	1.5	8.0	12.0	Q2
THS6132VFPR	HLQFP	VFP	32	1000	330.0	16.4	9.6	9.6	1.9	12.0	16.0	Q2

TAPE AND REEL BOX DIMENSIONS



*All dimensions are nominal

Device	Package Type	Package Drawing	Pins	SPQ	Length (mm)	Width (mm)	Height (mm)
THS6132RGWR	QFN	RGW	20	3000	340.5	333.0	20.6
THS6132VFPR	HLQFP	VFP	32	1000	346.0	346.0	33.0

RGW (S-PQFP-N20)

PLASTIC QUAD FLATPACK

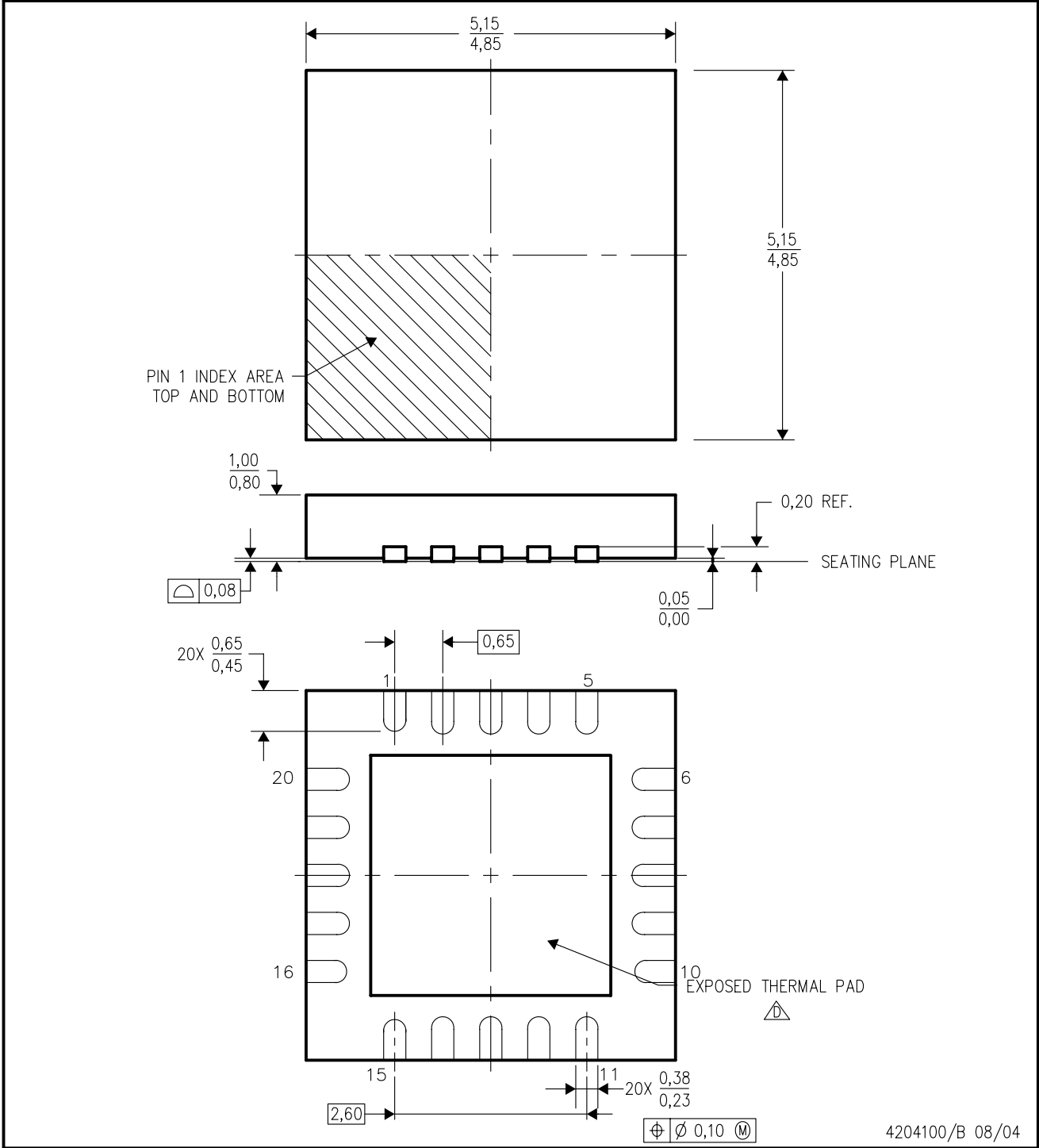

- NOTES: A. All linear dimensions are in millimeters. Dimensioning and tolerancing per ASME Y14.5-1994.
- B. This drawing is subject to change without notice.
- C. Quad Flat pack, No-leads (QFN) package configuration
- △ The package thermal pad must be soldered to the board for thermal and mechanical performance.. See the Product Data Sheet for details regarding the exposed thermal pad dimensions.
- E. Falls within JEDEC MO-220.

THERMAL INFORMATION

This package incorporates an exposed thermal pad that is designed to be attached directly to an external heatsink. The thermal pad must be soldered directly to the printed circuit board (PCB). After soldering, the PCB can be used as a heatsink. In addition, through the use of thermal vias, the thermal pad can be attached directly to a ground or power plane (whichever is applicable), or alternatively, a special heatsink structure designed into the PCB. This design optimizes the heat transfer from the integrated circuit (IC).

For information on the Quad Flatpack No-Lead (QFN) package and its advantages, refer to Application Report, Quad Flatpack No-Lead Logic Packages, Texas Instruments Literature No. SCBA017. This document is available at www.ti.com.

The exposed thermal pad dimensions for this package are shown in the following illustration.

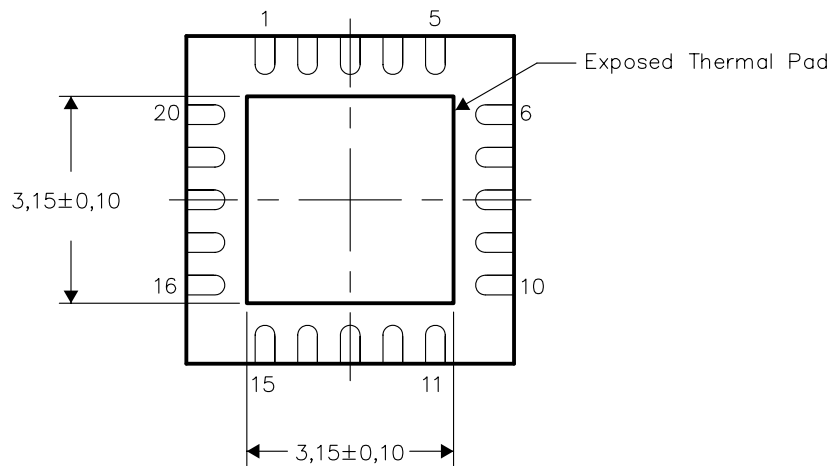

Bottom View

NOTE: All linear dimensions are in millimeters

Exposed Thermal Pad Dimensions

RGW (S-PQFP-N20)

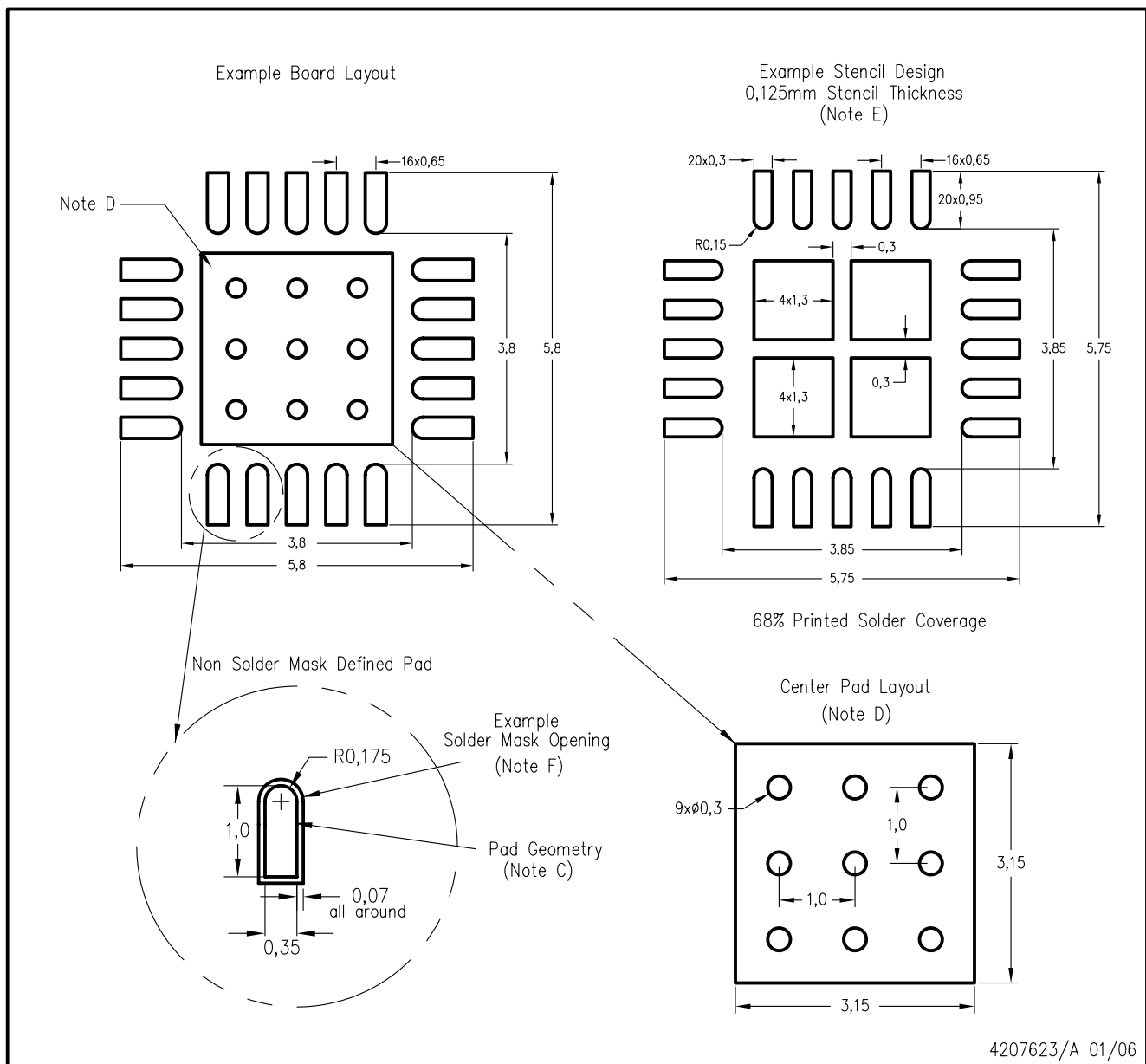

4207623/A 01/06

- NOTES:
- A. All linear dimensions are in millimeters.
 - B. This drawing is subject to change without notice.
 - C. Publication IPC-7351 is recommended for alternate designs.
 - D. This package is designed to be soldered to a thermal pad on the board. Refer to Application Note, QFN Packages, Texas Instruments Literature No. SCBA017, SLUA271, and also the Product Data Sheets for specific thermal information, via requirements, and recommended board layout. These documents are available at www.ti.com <<http://www.ti.com>>.
 - E. Laser cutting apertures with trapezoidal walls and also rounding corners will offer better paste release. Customers should contact their board assembly site for stencil design recommendations. Refer to IPC 7525 for stencil design considerations.
 - F. Customers should contact their board fabrication site for solder mask tolerances.

VFP (S-PQFP-G32)

PowerPAD™ PLASTIC QUAD FLATPACK

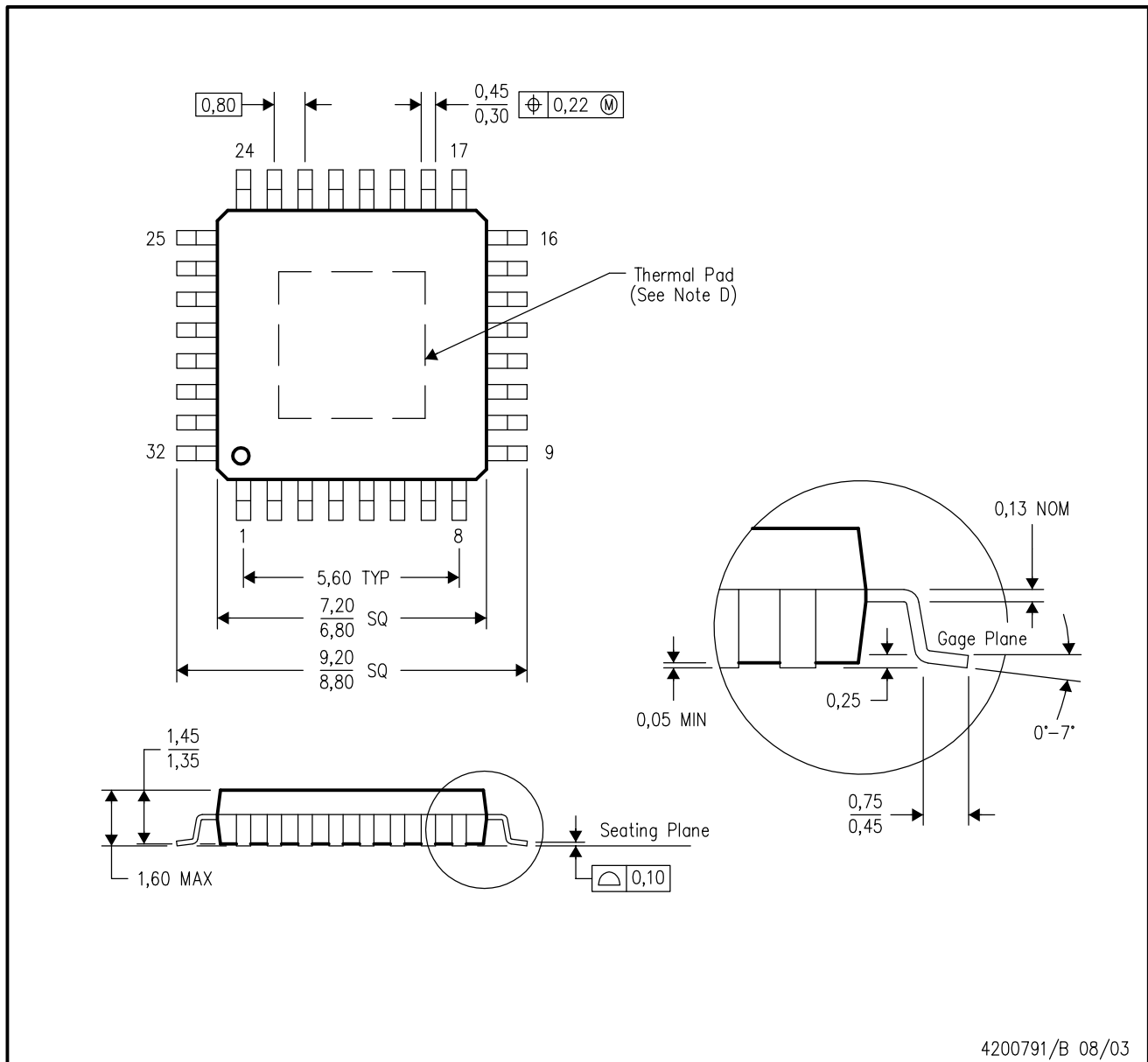

- NOTES:
- A. All linear dimensions are in millimeters.
 - B. This drawing is subject to change without notice.
 - C. Body dimensions do not include mold flash or protrusion.
 - D. This package is designed to be soldered to a thermal pad on the board. Refer to Technical Brief, PowerPad Thermally Enhanced Package, Texas Instruments Literature No. SLMA002 for information regarding recommended board layout. This document is available at www.ti.com <<http://www.ti.com>>.
 - E. Falls within JEDEC MS-026
 - F. PowerPAD is a trademark of Texas Instruments Incorporated.

PowerPAD is a trademark of Texas Instruments.

THERMAL INFORMATION

This PowerPAD™ package incorporates an exposed thermal pad that is designed to be attached directly to an external heatsink. The thermal pad must be soldered directly to the printed circuit board (PCB). After soldering, the PCB can be used as a heatsink. In addition, through the use of thermal vias, the thermal pad can be attached directly to the appropriate copper plane shown in the electrical schematic for the device, or alternatively, can be attached to a special heatsink structure designed into the PCB. This design optimizes the heat transfer from the integrated circuit (IC).

For additional information on the PowerPAD package and how to take advantage of its heat dissipating abilities, refer to Technical Brief, PowerPAD Thermally Enhanced Package, Texas Instruments Literature No. SLMA002 and Application Brief, PowerPAD Made Easy, Texas Instruments Literature No. SLMA004. Both documents are available at www.ti.com.

The exposed thermal pad dimensions for this package are shown in the following illustration.

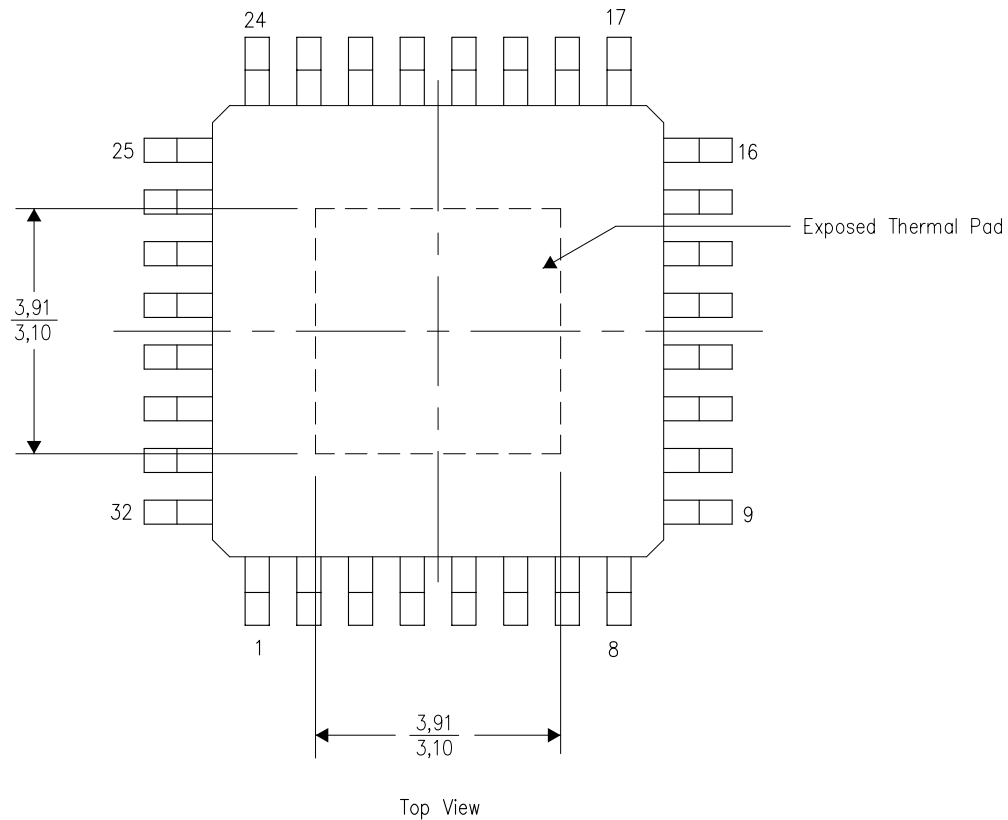

NOTE: All linear dimensions are in millimeters

Exposed Thermal Pad Dimensions

VFP (S-PQFP-G32) PowerPAD™

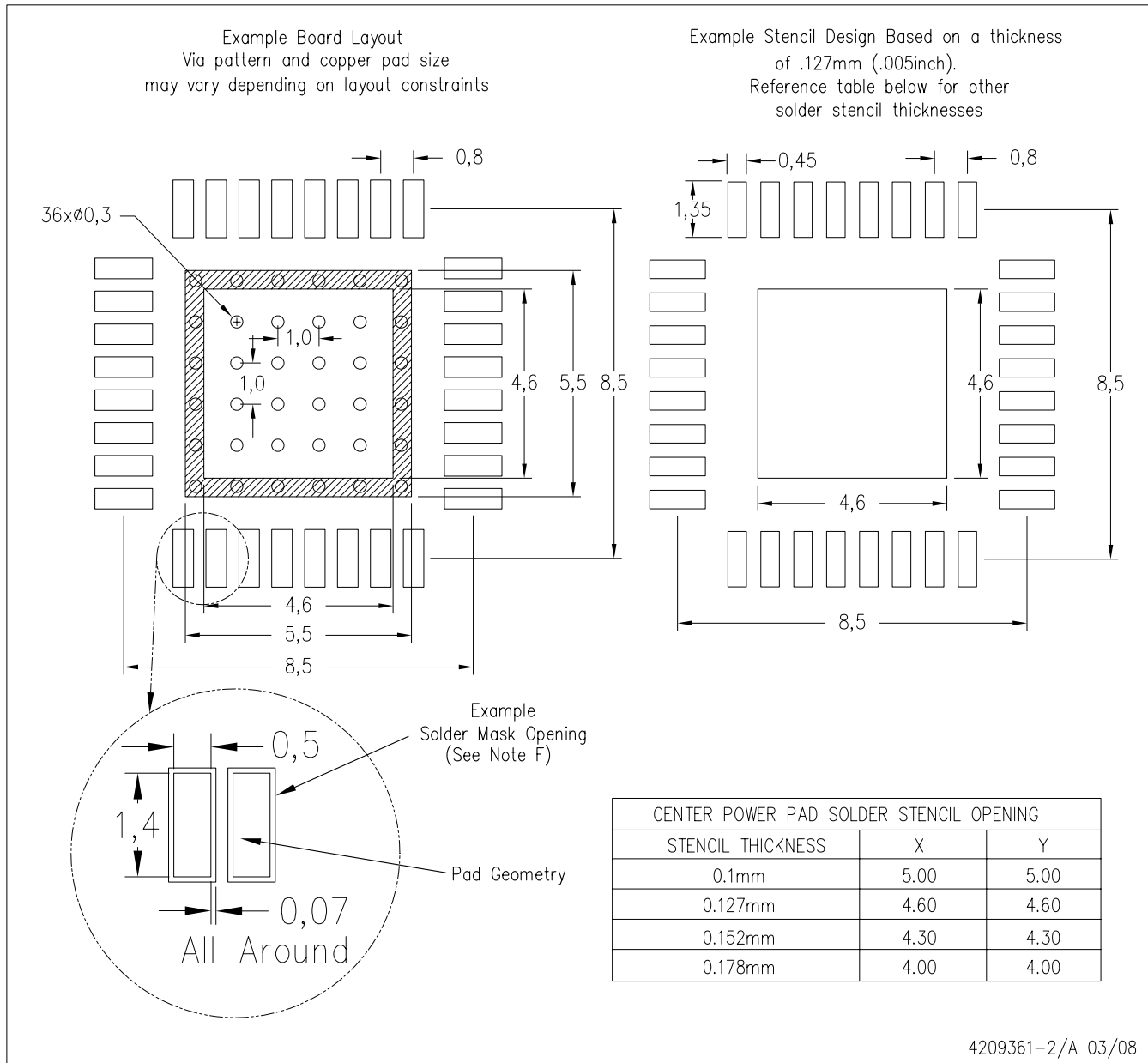

- NOTES:
- A. All linear dimensions are in millimeters.
 - B. This drawing is subject to change without notice.
 - C. Customers should place a note on the circuit board fabrication drawing not to alter the center solder mask defined pad.
 - D. This package is designed to be soldered to a thermal pad on the board. Refer to Technical Brief, PowerPAD Thermally Enhanced Package, Texas Instruments Literature No. SLMA002, SLMA004, and also the Product Data Sheets for specific thermal information, via requirements, and recommended board layout. These documents are available at www.ti.com <<http://www.ti.com>>. Publication IPC-7351 is recommended for alternate designs.
 - E. Laser cutting apertures with trapezoidal walls and also rounding corners will offer better paste release. Customers should contact their board assembly site for stencil design recommendations. Example stencil design based on a 50% volumetric metal load solder paste. Refer to IPC-7525 for other stencil recommendations.
 - F. Customers should contact their board fabrication site for solder mask tolerances between and around signal pads.

PowerPAD is a trademark of Texas Instruments.

IMPORTANT NOTICE

Texas Instruments Incorporated and its subsidiaries (TI) reserve the right to make corrections, modifications, enhancements, improvements, and other changes to its products and services at any time and to discontinue any product or service without notice. Customers should obtain the latest relevant information before placing orders and should verify that such information is current and complete. All products are sold subject to TI's terms and conditions of sale supplied at the time of order acknowledgment.

TI warrants performance of its hardware products to the specifications applicable at the time of sale in accordance with TI's standard warranty. Testing and other quality control techniques are used to the extent TI deems necessary to support this warranty. Except where mandated by government requirements, testing of all parameters of each product is not necessarily performed.

TI assumes no liability for applications assistance or customer product design. Customers are responsible for their products and applications using TI components. To minimize the risks associated with customer products and applications, customers should provide adequate design and operating safeguards.

TI does not warrant or represent that any license, either express or implied, is granted under any TI patent right, copyright, mask work right, or other TI intellectual property right relating to any combination, machine, or process in which TI products or services are used. Information published by TI regarding third-party products or services does not constitute a license from TI to use such products or services or a warranty or endorsement thereof. Use of such information may require a license from a third party under the patents or other intellectual property of the third party, or a license from TI under the patents or other intellectual property of TI.

Reproduction of TI information in TI data books or data sheets is permissible only if reproduction is without alteration and is accompanied by all associated warranties, conditions, limitations, and notices. Reproduction of this information with alteration is an unfair and deceptive business practice. TI is not responsible or liable for such altered documentation. Information of third parties may be subject to additional restrictions.

Resale of TI products or services with statements different from or beyond the parameters stated by TI for that product or service voids all express and any implied warranties for the associated TI product or service and is an unfair and deceptive business practice. TI is not responsible or liable for any such statements.

TI products are not authorized for use in safety-critical applications (such as life support) where a failure of the TI product would reasonably be expected to cause severe personal injury or death, unless officers of the parties have executed an agreement specifically governing such use. Buyers represent that they have all necessary expertise in the safety and regulatory ramifications of their applications, and acknowledge and agree that they are solely responsible for all legal, regulatory and safety-related requirements concerning their products and any use of TI products in such safety-critical applications, notwithstanding any applications-related information or support that may be provided by TI. Further, Buyers must fully indemnify TI and its representatives against any damages arising out of the use of TI products in such safety-critical applications.

TI products are neither designed nor intended for use in military/aerospace applications or environments unless the TI products are specifically designated by TI as military-grade or "enhanced plastic." Only products designated by TI as military-grade meet military specifications. Buyers acknowledge and agree that any such use of TI products which TI has not designated as military-grade is solely at the Buyer's risk, and that they are solely responsible for compliance with all legal and regulatory requirements in connection with such use.

TI products are neither designed nor intended for use in automotive applications or environments unless the specific TI products are designated by TI as compliant with ISO/TS 16949 requirements. Buyers acknowledge and agree that, if they use any non-designated products in automotive applications, TI will not be responsible for any failure to meet such requirements.

Following are URLs where you can obtain information on other Texas Instruments products and application solutions:

Products

Amplifiers	amplifier.ti.com
Data Converters	dataconverter.ti.com
DSP	dsp.ti.com
Clocks and Timers	www.ti.com/clocks
Interface	interface.ti.com
Logic	logic.ti.com
Power Mgmt	power.ti.com
Microcontrollers	microcontroller.ti.com
RFID	www.ti-rfid.com
RF/IF and ZigBee® Solutions	www.ti.com/lprf

Applications

Audio	www.ti.com/audio
Automotive	www.ti.com/automotive
Broadband	www.ti.com/broadband
Digital Control	www.ti.com/digitalcontrol
Medical	www.ti.com/medical
Military	www.ti.com/military
Optical Networking	www.ti.com/opticalnetwork
Security	www.ti.com/security
Telephony	www.ti.com/telephony
Video & Imaging	www.ti.com/video
Wireless	www.ti.com/wireless

Mailing Address: Texas Instruments, Post Office Box 655303, Dallas, Texas 75265
Copyright © 2008, Texas Instruments Incorporated